

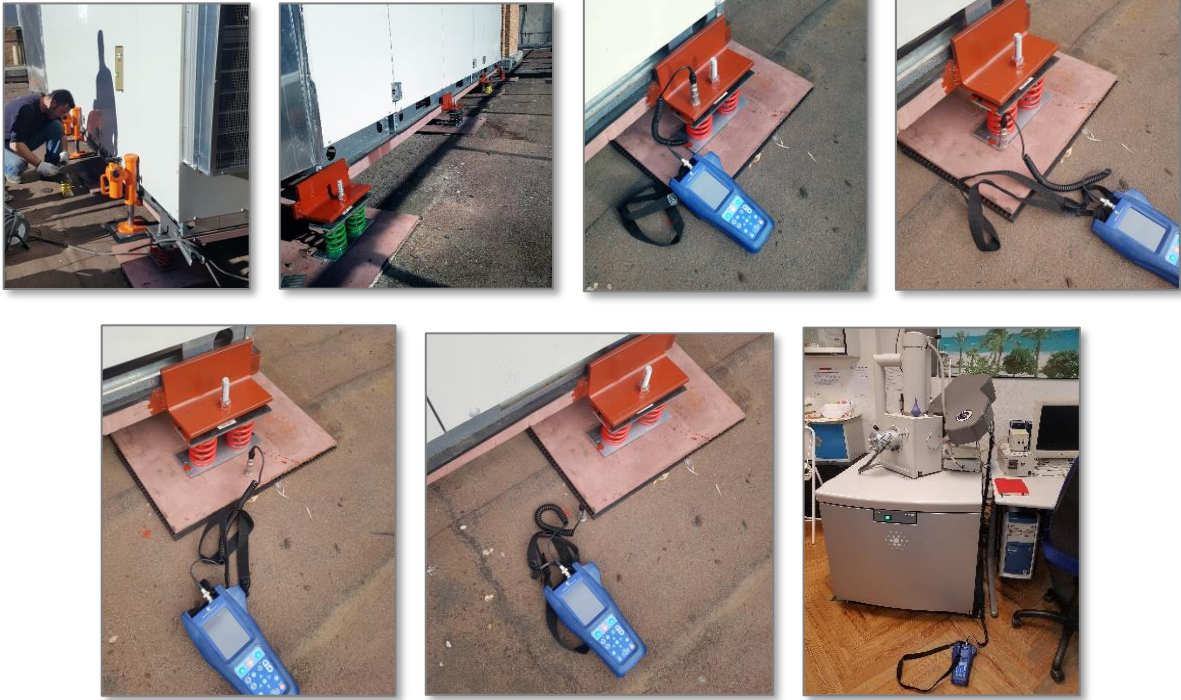

TRATAMIENTOS ANTIVIBRATORIOS

MUSEO DE CIENCIAS NATURALES – ADECUACIÓN VIBRACIÓN UNIDAD CLIMA PARA FUNCIONAMIENTO DE MICROSCOPIO ELECTRÓNICO DE ALTA RESOLUCIÓN – MADRID



AcusVib, S.L.U. Inscrita en el Registro Mercantil de Madrid TOMO 34.289 FOLIO 67 SECCION 8 HOJA M-616835 INSCRIPCION 2

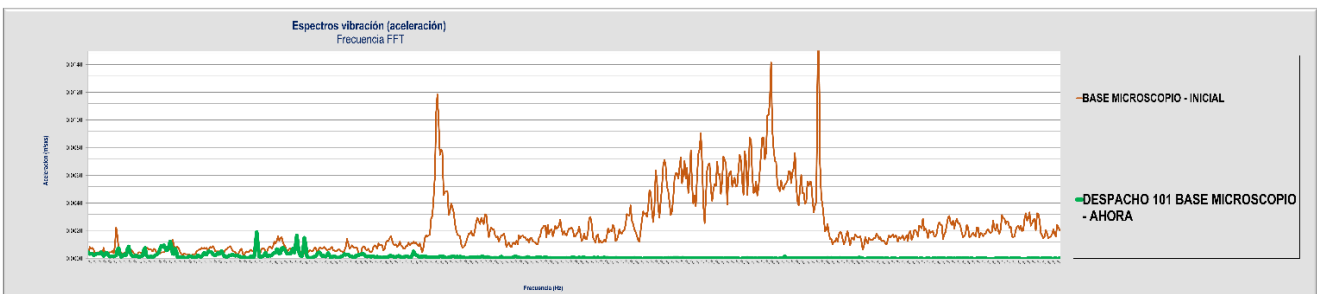
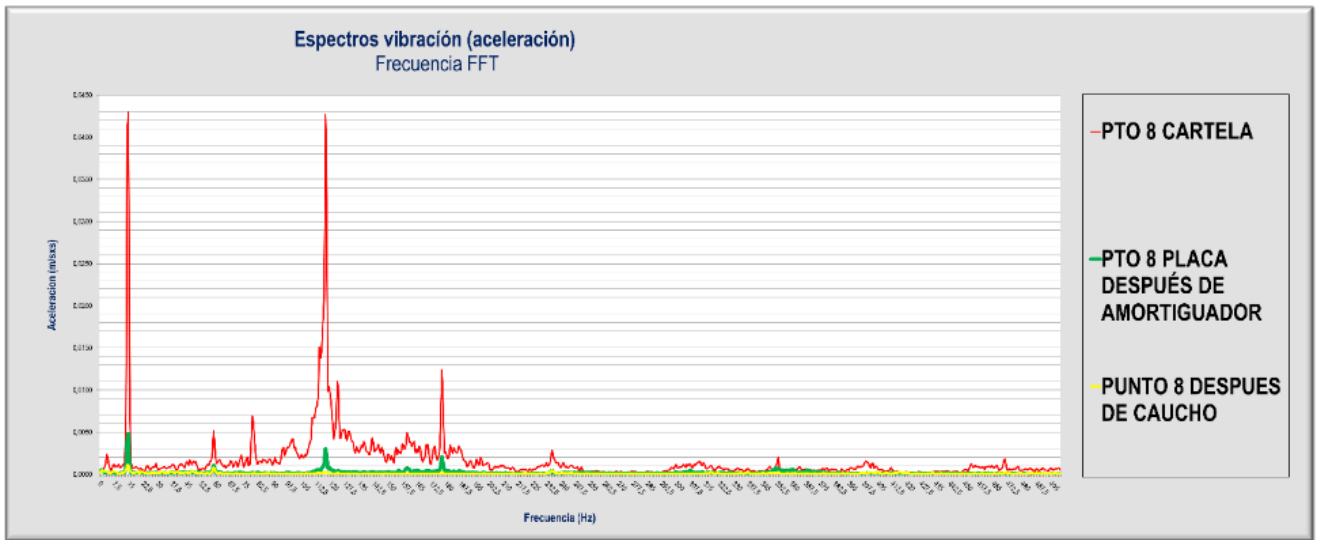



CONGRESO DE LOS DIPUTADOS - AMORTIGUACIÓN INSTALACIONES FRÍO - MADRID

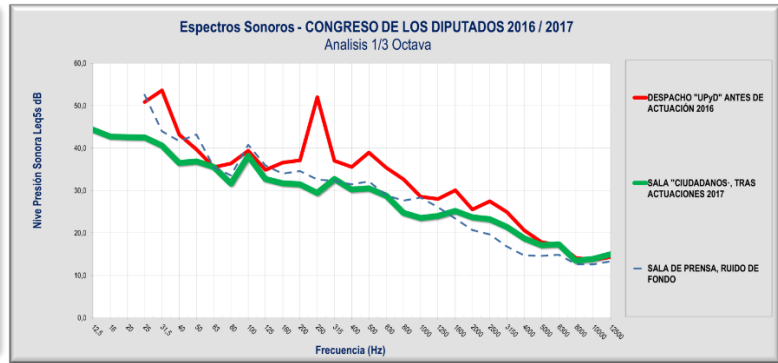
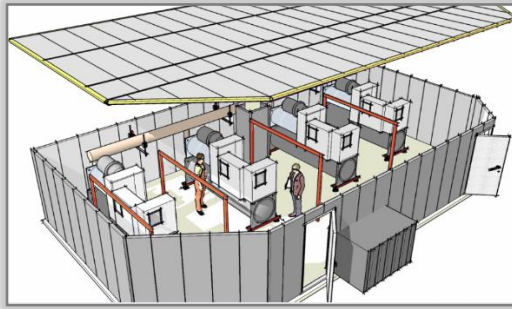

COMPARATIVA VIBRACION

FUERA DEL SUELO FLOTANTE

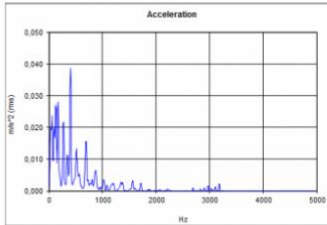

O.A. value (ms⁻² (rms)) | 0,07888

VALOR GLOBAL



SOBRE SOLERA SUELO FLOTANTE

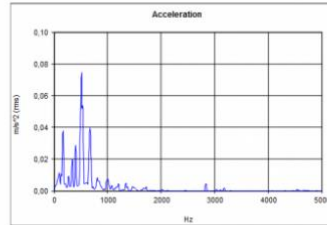

O.A. value (ms⁻² (rms)) | 0,1292

VALOR GLOBAL

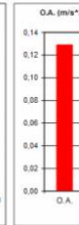

ESTRUCTURA MÁQUINA, DEBAJO DE AMORTIGUADORES

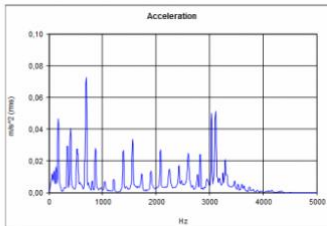

O.A. value (ms⁻² (rms)) | 0,1663



ESTRUCTURA MÁQUINA, SIN PASAR POR AMORTIGUACIÓN

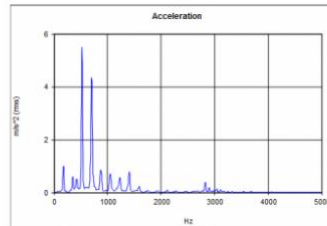

O.A. value (ms⁻² (rms)) | 7,834



ESTRUCTURA SOPORTE CONDUCCIONES, TRAS PASAR POR AMORTIGUACIÓN

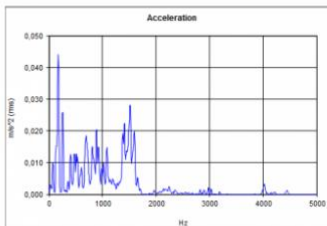

O.A. value (ms⁻² (rms)) | 0,1032

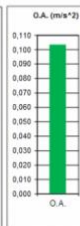

ESTRUCTURA SOPORTE TUBERIAS, ANTES DE AMORTIGUACIÓN

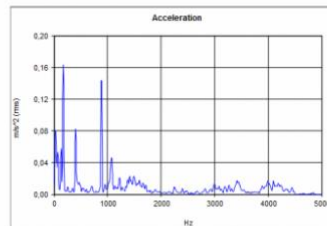

O.A. value (ms⁻² (rms)) | 0,2922

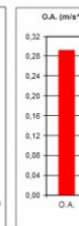



Edificio "Torre BBVA" - Bancadas Inercia Bombas – Madrid

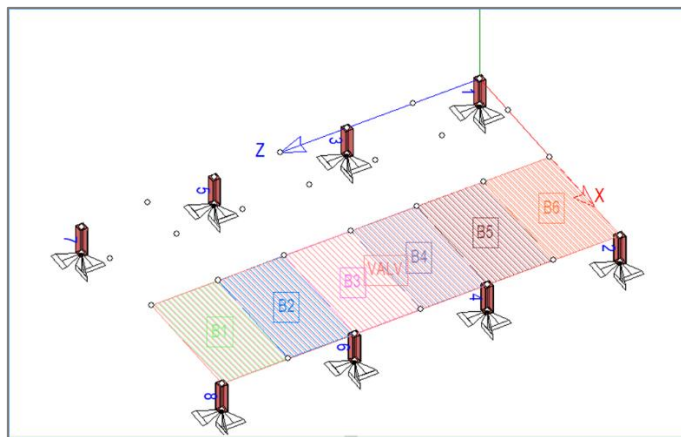
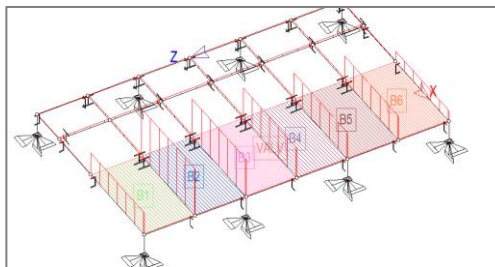
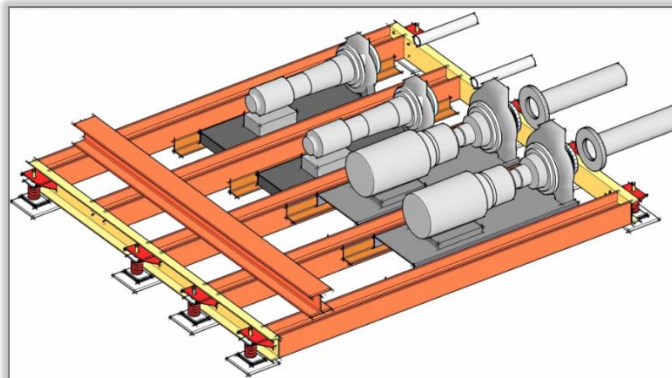

Reacciones. Ejes generales, Acero, E.L.U., sin mayorar								
NN	Mx(mT)	My	Mz	Fx(T)	Fyton	Fz		
1	0,00	0,00	0,00	0,21	0,16	0,02	160	
2	0,01	0,00	0,02	0,00	0,36	0,13	360	
3	0,00	0,00	0,00	0,43	0,45	0,01	450	
4	0,00	0,00	0,04	0,00	0,97	0,00	970	
5	0,00	0,00	0,00	0,60	0,58	0,00	580	
6	0,02	0,00	0,05	0,00	1,44	0,14	1.440	
7	0,00	0,00	0,00	0,45	0,29	0,00	290	
8	0,00	0,00	0,04	0,00	0,74	0,00	740	
							4.990	Kg



ALCAMPO - Jerez de la Frontera - Grupos de Frío



DECATHLON - Amortiguación Uds. cubierta - Parla

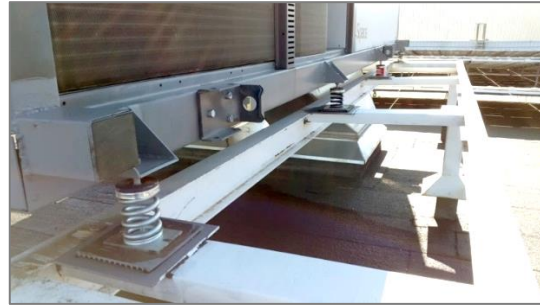

Sala de calderas comunidad propietarios – Madrid



HM Hospitales - Amortiguación Equipos frío - Móstoles





Comunidad de Propietarios - Amortiguación Bombas y colectores – Las Rozas

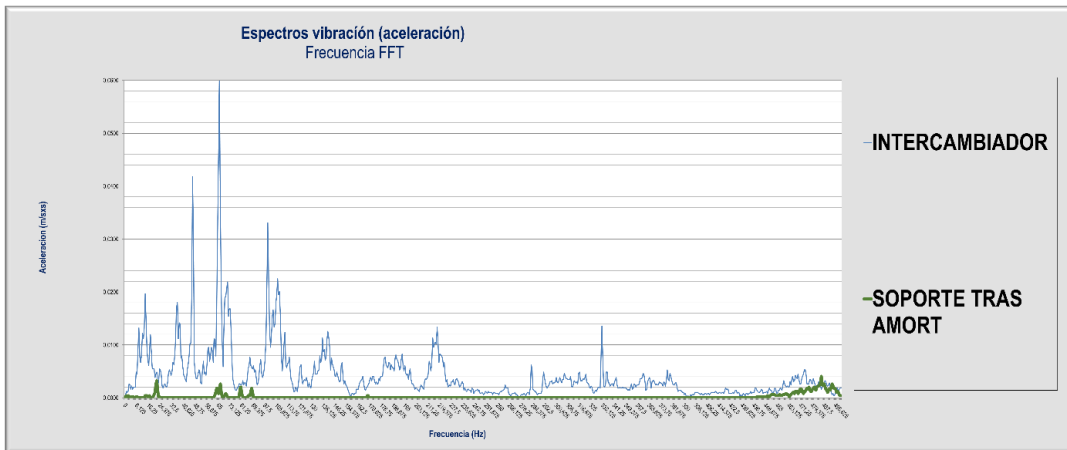
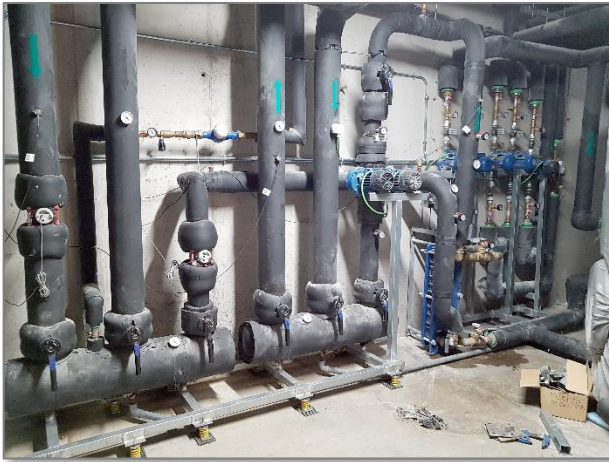

HM Hospitales – Caliqua - Amortiguación Bombas equipo Resonancia Magnética – Getafe

